

INSTALLATION INSTRUCTIONS

AGUZZO[®]
BEAUTIFUL BATHWARE

304 Stainless Steel **EZY-FIT** Heated Towel Rail

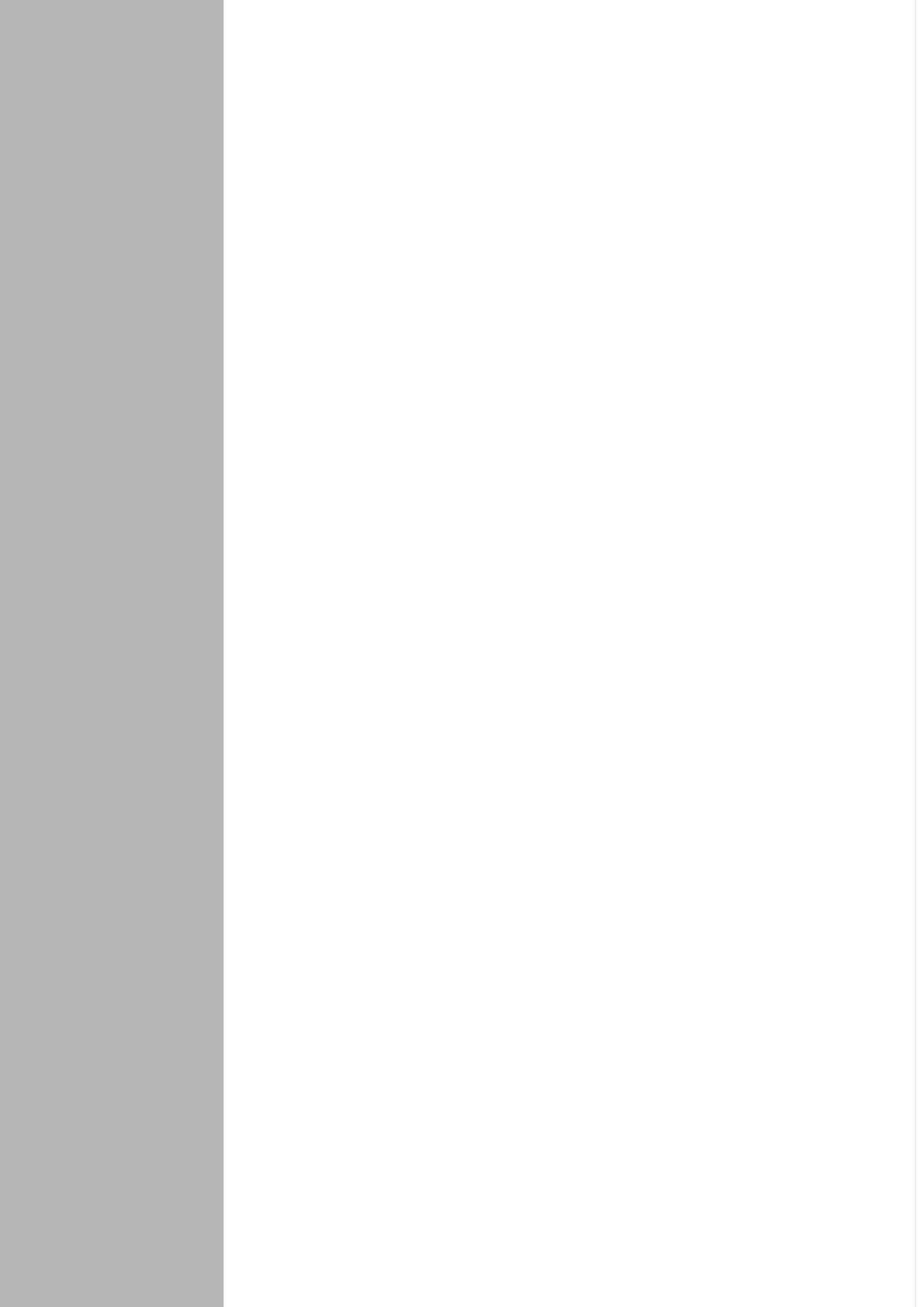



All products are made from thick 304-grade Stainless Steel

ROUND BAR



COLOUR FINISHES:

- Polished (*matches Chrome*)
- Brushed Nickel
- Matte Black PVD
- Brushed Brass PVD
- Rose Gold PVD
- Gun Metal PVD

SIZES:

- 600mm (W) x 920mm (H)
- 750mm (W) x 700mm (H)
- 900mm (W) x 920mm (H)

SQUARE BAR



COLOUR FINISHES:

- Polished (*matches Chrome*)
- Matte Black PVD

SIZES:

- 600mm (W) x 920mm (H)
- 750mm (W) x 700mm (H)
- 900mm (W) x 920mm (H)

FLAT BAR



COLOUR FINISHES:

- Polished (*matches Chrome*)
- Matte Black PVD

SIZES:

- 600mm (W) x 920mm (H)
- 750mm (W) x 700mm (H)
- 900mm (W) x 920mm (H)

VERTICAL SQUARE BAR



COLOUR FINISHES:

- Polished (*matches Chrome*)
- Brushed Nickel
- Matte Black PVD
- Brushed Brass PVD
- Rose Gold PVD
- Gun Metal PVD

TYPES

- Single Bar
- Double Bar

VERTICAL ROUND FLAT BAR



COLOUR FINISHES:

- Polished (*matches Chrome*)
- Brushed Nickel
- Matte Black PVD
- Brushed Brass PVD
- Rose Gold PVD
- Gun Metal PVD

HEIGHT

- 1500mm

VERTICAL ROUND TREE-STYLE



COLOUR FINISHES:

- Polished (*matches Chrome*)
- Brushed Nickel
- Matte Black PVD
- Brushed Brass PVD
- Rose Gold PVD
- Gun Metal PVD

HEIGHT OPTIONS

- 900mm
- 1500mm

Key Specifications

Construction: 304 Stainless Steel -- corrosion protection -- no chrome
Electrical: Tested and certified to comply with AS/NZ: 60335 and c-tick requirements
IP55 Rated: Water splash and spray proof
Power supply: 220-240 Vac. 50/60Hz
Approval: CE, EMC(C-Tick), LVD, RoHS, SAA(AS/NZ 60335), PSE(J60335-1), IP55



Important Safeguards

Note: This appliance is not intended for use by persons (including children) with reduced physical, sensory, or mental capabilities, or lack of experience and knowledge, unless they have been given supervision or instruction concerning use of the appliance by a person responsible for their safety. Children should be supervised to ensure that they do not play with the appliance.

- Eliminate choking and suffocation hazards for young children by removing and safely discarding all protective packaging and the protective cover on the power plug.
- This appliance operates at a room temperature that is hot but not scalding to touch (up to 55°C). Rises in ambient temperature and the insulation effect of towels can cause the operating temperature to rise. Young children and infirm persons should be supervised near this appliance.
- Do **NOT** use this towel rail to dry clothing or articles that have been in contact with oil, petroleum based products, or dry cleaning fluids.
- Use this appliance **ONLY** on the voltage specified on its electrical specification label.
- Do **NOT** use this appliance other than for its intended use.
- IPX5 rated to withstand water splashes and sprays. Do **NOT** immerse in liquid.
- Do **NOT** allow the power supply cord to come into contact with any heated surfaces.

Installation Requirements

- Carefully read all instructions before installation and operation
- If you are hard-wiring or connecting to switch/controller. this appliance **MUST** be installed by a qualified and licenced electrician in accordance with relevant wiring rules (AS/NZ 3000:2000 in Australia and New Zealand)
- It **MUST** be installed so the bottom rail is at least 600mm from the floor
- It **MUST** be installed at least 1.7 metres from combustible materials such as drapes and furnishings
- The appliance is supplied with an earthed 3-core supply cord and plug. This cord and plug **MUST** be positioned so it is not subject to splashing water or ingress of moisture
- Install with a suitable switch or controller:
 - Plug into a power point with a switch
 - Hardwire to a wall switch
 - Hardwire to a compatible controller (such as a timer or thermostat switch)
- Do **NOT** install or operate with a damaged cord or plug
- Do **NOT** cover the cord and ensure it is arranged so it does not pose a risk
- Do **NOT** install outdoors

Installation Instructions for Vertical Heated Towel Rails with Round Mounting Covers

Concealed Wiring (Hard Wire) Installation

NOTE: Hard wiring requires a licensed electrician to complete the wiring

Installation kit inclusions:



Ezy-Fit Plug-in Installation: If you wish to simply plug your new heated towel rail into a power point, then go to the section below on "Plug-in Installation".

Ezy-Fit Hard Wire Installation: The heated towel rail can be hard-wired in five easy steps

THIS IS FOR THE HARD WIRE OPTION ONLY. IF SIMPLY PLUGGING IN, GO TO SEPARATE INSTRUCTION SET.

STEP 1:

Assemble the rail and mounting kit

Insert screw M6*50 through the round decorative cap and connect to the back side of the towel rail leg.

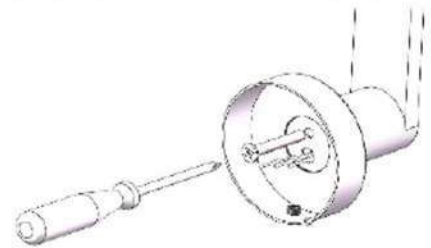

STEP 2:

Select the desired mounting position

Hold the rail against the wall or utilise a tape measure to aide in marking the drill spots on the wall.

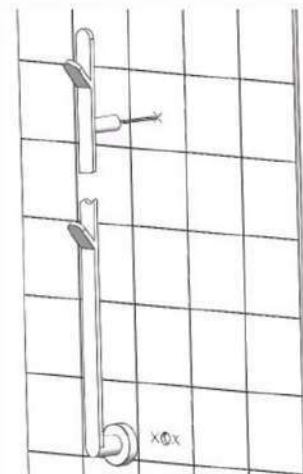

STEP 3:

Drill mounting holes

The holes must be on each side of the supply cable (power connection). Then fit the rail plugs on the matching holes.

Installation Instructions for Vertical Heated Towel Rails with Round Mounting Covers, cont.

Concealed Wiring (Hard Wire) Installation

STEP 4:

Affix mounting kit on the wall

Place one M4*30 screw through the fixing brackets and another two M4*30 screws through the mounting plate.

Then fix each of them in the two holes (the assembled mounting plate goes to the bottom hole).



STEP 5:

Connect the wires

Connect the core wires from the towel rail leg to the power wire coming out of the wall.

Fix the towel rail tube onto the mounting brackets, and use an Allen wrench to install the hex screws into the holes of all the tubes to complete the installation.

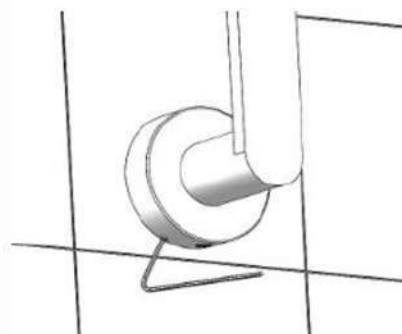
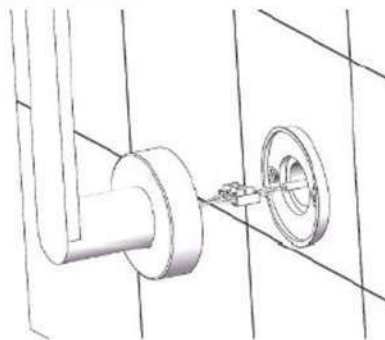

Warning: To prevent potential safety hazards, it is recommended that grounding and short circuit measurements be performed after installation of the device.

This should be done by a licensed electrician.

Installation Instructions for Vertical Heated Towel Rails with Round Mounting Covers

Plug-In Installation

STEP 1:

Assemble the rail and mounting kit

Insert screw M6*50 through the round decorative cap and connect to the back side of the towel rail leg.

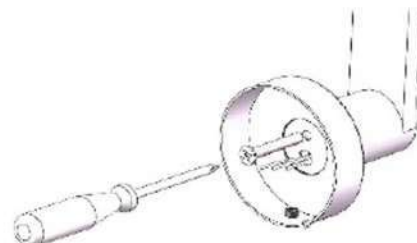

STEP 2:

Select the desired mounting position

Hold the rail against the wall or utilise a tape measure to aide in marking the drill spots on the wall.

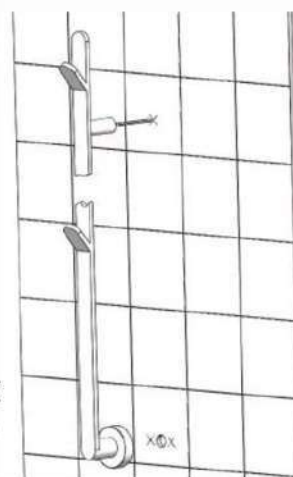

STEP 3:

Drill mounting holes

The holes must be on each side of the supply cat (power connection). Then fit the rail plugs on the matching holes.



STEP 4:

Affix mounting kit on the wall

Place one M4*30 screw through the fixing brackets and another two M4*30 screws through the mounting plate.

Then fix each of them in the two holes (the assembled mounting plate goes to the bottom hole).

Installation Instructions for Vertical Heated Towel Rails with Round Mounting Covers, cont. Plug-In Installation

STEP 5:

Prepare the cover plate for wire assembly

Remove the black plastic plug from the decorative round cover plate. This hole will be allocated to the power wire cable.

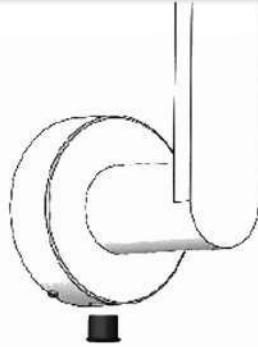

STEP 6:

Affix the wires

Put the included power wire through the waterproof connector. Affix with screws.

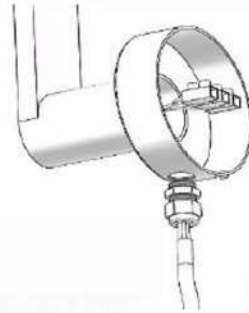

STEP 7:

Connect the wires

Connect the core wires from the towel rail leg to the power wire affixed through the round cover plate.

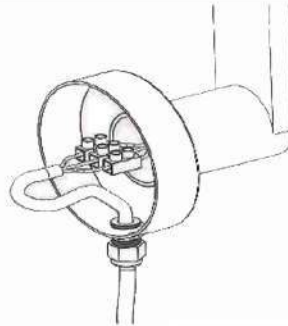

STEP 8:

Affix the rail into the wall

Fix the towel rail on the wall and use the Allen wrench to install the hex screws into the holes of all the tubes to complete the installation.

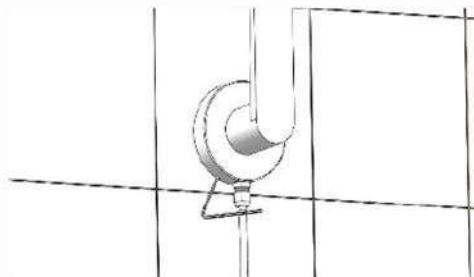

Warning: To prevent potential safety hazards, it is recommended that grounding and short circuit measurements be performed after installation of the device.

This should be done by a licensed electrician.

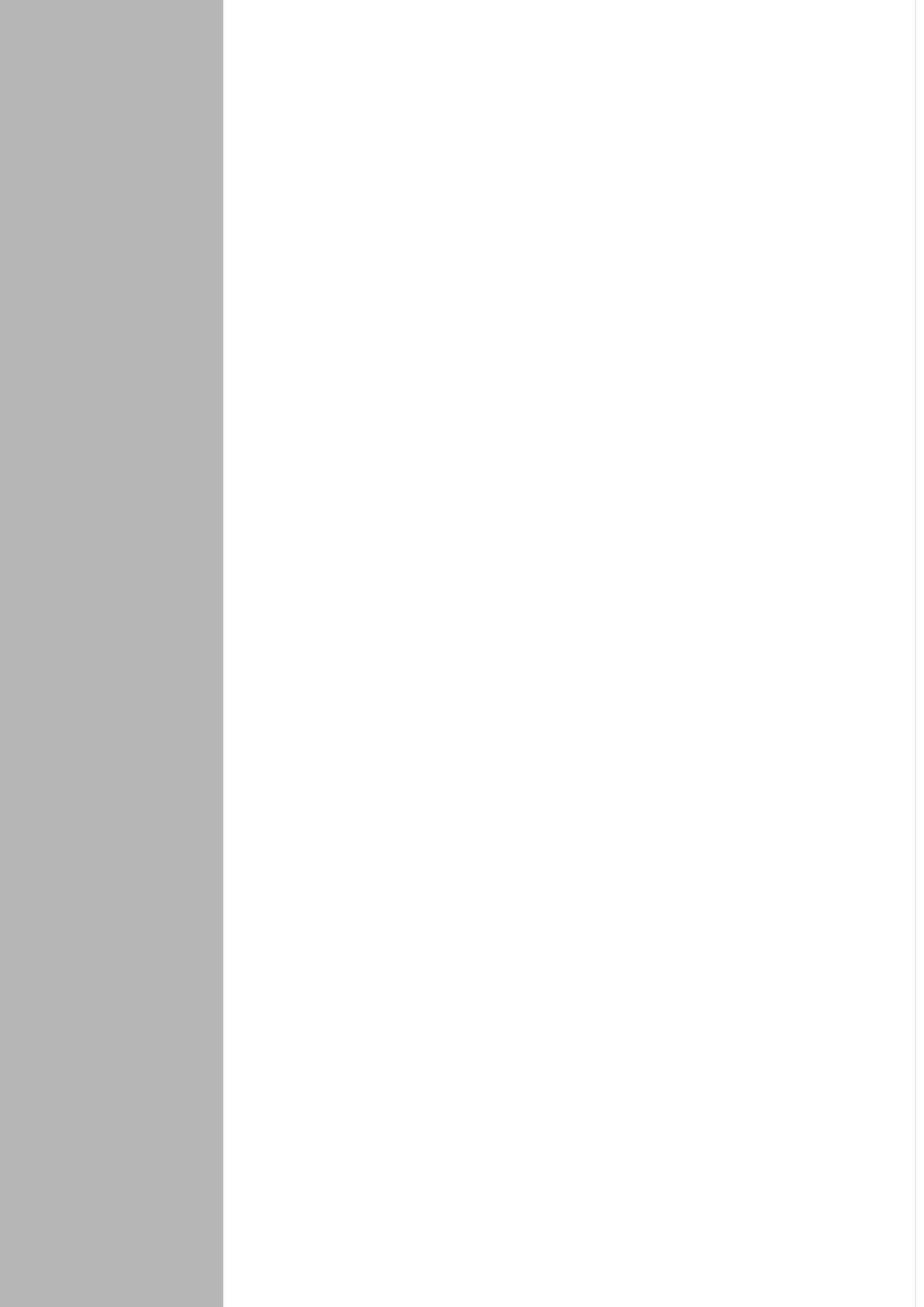

AQUZZO®

BEAUTIFUL BATHWARE