

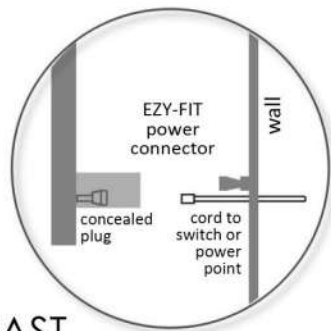

304 Stainless Steel
EZY-FIT

Vertical Heated Towel Rail



FAST
EZY-FIT
INSTALLATION





Key Specifications

Construction: 304 Stainless Steel -- corrosion protection -- no chrome
Electrical: Tested and certified to comply with AS/NZ: 60335 and c-tick requirements
IP55 Rated: Water splash and spray proof
Power supply: 220-240 Vac. 50/60Hz
Approval: CE, EMC(C-Tick), LVD, RoHS, SAA(AS/NZ 60335), PSE(J60335-1), IP55



Important Safeguards

Note: This appliance is not intended for use by persons (including children) with reduced physical, sensory, or mental capabilities, or lack of experience and knowledge, unless they have been given supervision or instruction concerning use of the appliance by a person responsible for their safety. Children should be supervised to ensure that they do not play with the appliance.

- Eliminate choking and suffocation hazards for young children by removing and safely discarding all protective packaging and the protective cover on the power plug.
- This appliance operates at a room temperature that is hot but not scalding to touch (up to 55°C). Rises in ambient temperature and the insulation effect of towels can cause the operating temperature to rise. Young children and infirm persons should be supervised near this appliance.
- Do **NOT** use this towel rail to dry clothing or articles that have been in contact with oil, petroleum based products, or dry cleaning fluids.
- Use this appliance **ONLY** on the voltage specified on its electrical specification label.
- Do **NOT** use this appliance other than for its intended use.
- IPX5 rated to withstand water splashes and sprays. Do **NOT** immerse in liquid.
- Do **NOT** allow the power supply cord to come into contact with any heated surfaces.

Installation Requirements

- Carefully read all instructions before installation and operation
- If you are hard-wiring or connecting to switch/controller. this appliance **MUST** be installed by a qualified and licenced electrician in accordance with relevant wiring rules (AS/NZ 3000:2000 in Australia and New Zealand)
- It **MUST** be installed so the bottom rail is at least 600mm from the floor
- It **MUST** be installed at least 1.7 metres from combustible materials such as drapes and furnishings
- The appliance is supplied with an earthed 3-core supply cord and plug. This cord and plug **MUST** be positioned so it is not subject to splashing water or ingress of moisture
- Install with a suitable switch or controller:
 - Plug into a power point with a switch
 - Hardwire to a wall switch
 - Hardwire to a compatible controller (such as a timer or thermostat switch)
- Do **NOT** install or operate with a damaged cord or plug
- Do **NOT** cover the cord and ensure it is arranged so it does not pose a risk
- Do **NOT** install outdoors

Aguzzo Heated Towel Rail Models

ROUND BAR



POLISHED STAINLESS STEEL

AGZHTR-RND-600-0855 - 600mm W x 920 H, Dual wired
 AGZHTR-RND-750-0856 - 750mm W x 700 H, Dual wired
 AGZHTR-RND-900-0857 - 900mm W x 920 H, Dual wired

MATTE BLACK ON STAINLESS STEEL

AGZHTR-RND-600-0855-B - 600mm W x 920 H, Dual wired
 AGZHTR-RND-750-0856-B - 750mm W x 700 H, Dual wired
 AGZHTR-RND-900-0857-B - 900mm W x 920 H, Dual wired

BRUSHED NICKEL ON STAINLESS STEEL

AGZHTR-RND-600-0855-N - 600mm W x 920 H, Dual wired
 AGZHTR-RND-750-0856-N - 750mm W x 700 H, Dual wired
 AGZHTR-RND-900-0857-N - 900mm W x 920 H, Dual wired

SQUARE BAR



POLISHED STAINLESS STEEL

AGZHTR-SQR-600-0858 - 600mm W x 920 H, Dual wired
 AGZHTR-SQR-750-0859 - 750mm W x 700 H, Dual wired
 AGZHTR-SQR-900-0860 - 900mm W x 920 H, Dual wired

MATTE BLACK ON STAINLESS STEEL

AGZHTR-SQR-600-0858-B - 600mm W x 920 H, Dual wired
 AGZHTR-SQR-750-0859-B - 750mm W x 700 H, Dual wired
 AGZHTR-SQR-900-0860-B - 900mm W x 920 H, Dual wired

FLAT BAR



POLISHED STAINLESS STEEL

AGZHTR-FLT-600-0861 - 600mm W x 920 H, Dual wired
 AGZHTR-FLT-750-0862 - 750mm W x 700 H, Dual wired
 AGZHTR-FLT-900-0863 - 900mm W x 920 H, Dual wired

MATTE BLACK ON STAINLESS STEEL

AGZHTR-FLT-600-0861-B - 600mm W x 920 H, Dual wired
 AGZHTR-FLT-750-0862-B - 750mm W x 700 H, Dual wired
 AGZHTR-FLT-900-0863-B - 900mm W x 920 H, Dual wired

VERTICAL RAILS



POLISHED STAINLESS STEEL

AGZHTR-VER-200-0865 - Single bar, 1400mm H, Bottom wired
 AGZHTR-VER-200-0864 - Double bar, 1400mm H, Bottom wired

MATTE BLACK ON STAINLESS STEEL

AGZHTR-VER-200-0865-B - Single bar, 1400mm H, Bottom wired
 AGZHTR-VER-200-0864-B - Double bar, 1400mm H, Bottom wired

BRUSHED NICKEL ON STAINLESS STEEL

AGZHTR-VER-200-0865-N - Single bar, 1400mm H, Bottom wired
 AGZHTR-VER-200-0864-N - Double bar, 1400mm H, Bottom wired

EZY-FIT Hard Wire Installation

The new EZY-FIT installation system can significantly save time when planning to hard-wire (concealed wiring) your new heated towel rail.

NOTE: Hard wiring requires a licensed electrician to complete the wiring

Ezy-Fit Plug-in Installation: If you wish to simply plug your new heated towel rail into a power point, then go to the section below on "Plug-in Installation".

Ezy-Fit Hard Wire Installation: The heated towel rail can be hard-wired in four easy steps

THIS IS FOR THE HARD WIRE OPTION ONLY. IF SIMPLY PLUGGING IN, GO TO SEPARATE INSTRUCTION SET.

STEP 1:

Hard wire power cord

Have a licensed electrician cut off the mains power plug and hard wire the power supply cord to a wall switch or compatible timer/controller (sold separately). Measure where the power cord needs to exit the wall (see Steps 2 and 3). The EZY-FIT power connector plug should be protruding from the wall for final installation.

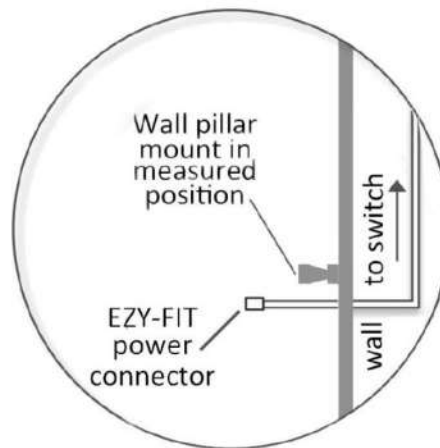

STEP 2:

Connect wall brackets

Connect the wall brackets to the unit using the hex key and bolts provided. Use standard brackets (A) for the non-cabled connection points. Use the cable housing brackets (B) for the cabled connection points.

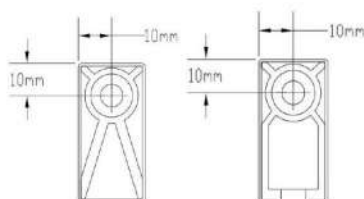

(A) Standard Bracket Profile
(B) Cable Housing Bracket Profile

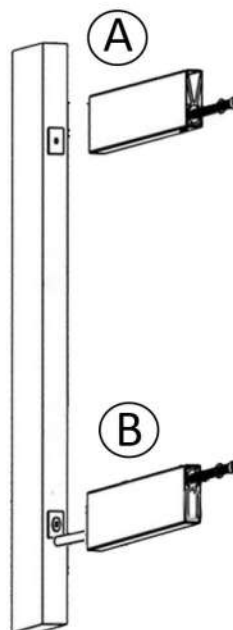

EZY-FIT Plug-in Installation

The heated towel rail comes ready to simply mount on the wall and plug into a power point. Follow these easy steps:

STEP 1:

Prepare the cabled wall bracket

On the wall bracket that will house the power cable, use a sharp utility knife to cut out the plastic hole cover at the end of the bracket. This is where the power cable will exit the bracket to plug into a power point.

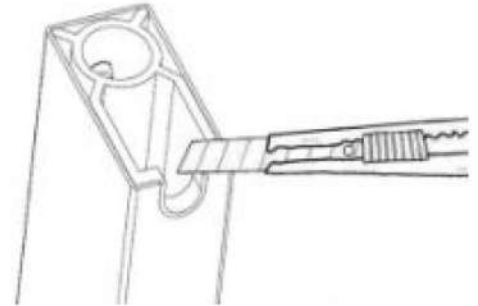

Feed the female Ezy-Fit connector on the supplied power cord through the cable housing wall bracket and securely connect it to the male Ezy-Fit connector exiting the unit. Securely tighten the screw collar on this connection, and then connect the cable housing bracket to the unit (see Step 3).

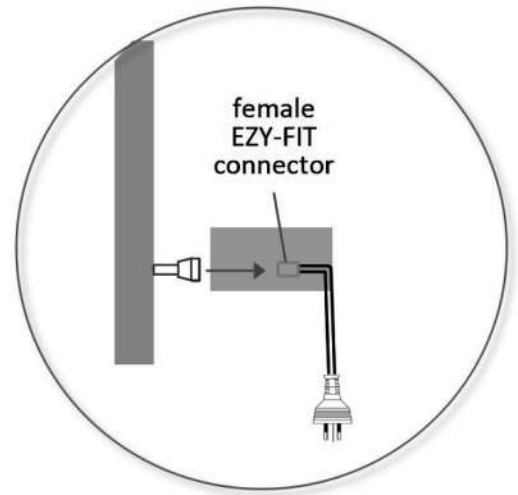

STEP 2:

Connect wall brackets

Connect the wall brackets to the unit. Use standard brackets (A) for the non-cabled connection points. Use the cable housing brackets (B) for the cabled connection points.

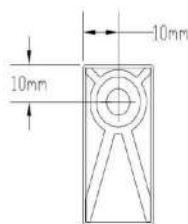

(A) Standard Bracket Profile

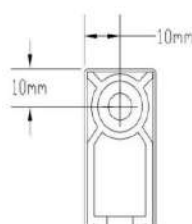

(B) Cable Housing Bracket Profile

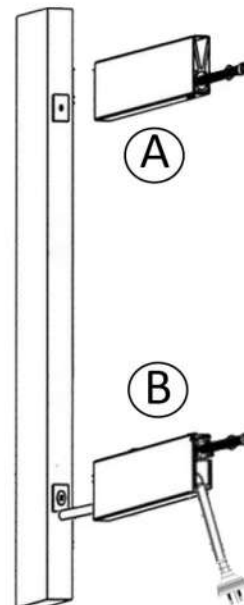

EZY-FIT Plug-in Installation, cont.

STEP 3:

Measure for wall mount positions and mount

Once the wall is finished, use the assembled unit to measure and mark the required wall positions for the wall pillars. Affix the wall pillars securely using the supplied screws and wall plugs, or other fasteners if more appropriate. Ensure the wall pillars are securely anchored.

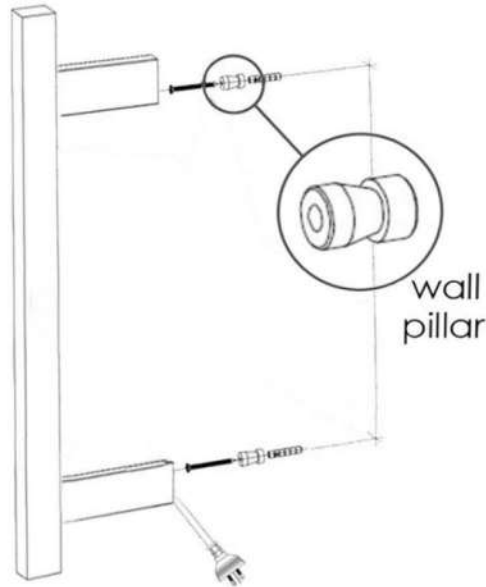

Position the unit over the pre-installed wall pillars. Secure the unit to the wall pillars by apply pressure to the front of the unit whilst tightening the grub screw on each wall bracket with the hex key supplied so the unit is securely locked into position Plug into power point.

IMPORTANT: Aguzzo Heated Towel Rails are designed to have some limited flex so that they can fit securely to walls that present slightly uneven or non-flat surfaces

Security Warning

1. This product is used only for drying textile materials washed in water.
2. This product should be fixed only in areas away from water. DO NOT immerse in water.
3. If the power cord is damaged, in order to avoid danger, the cord must be repaired by an electrician or returned to the manufacturer.

CARE Instructions

Your AGUZZO Heated Towel Rail is constructed from high grade 304 stainless steel and is easy to keep clean. Do not attempt to clean when the product is on or the surface is hot.

Polished Stainless Steel Finish

- Simply clean with soapy water or approved stainless steel cleaners
- Do not clean with solvents, alcohol, chemical or abrasive cleaners

Matte Black Finish

- Simply clean with soapy water
- Avoid wax based cleaners as these will act to smooth out the matte finish
- Do not clean with solvents, alcohol, chemical or abrasive cleaners

NOTE: Damage to the surface from improper care is not covered by the product warranty

WARRANTY: 5 Year Protection

Purchasing a quality product from AGUZZO (Vanguard Design Group Pty. Ltd. A.C.N. 104 411 314) (we, us, our, or Aguzzo) comes with this comprehensive 5 year warranty.

Please read this Aguzzo Warranty Policy (the Warranty or Warranty Policy) carefully to ensure that the purchaser (you or the Purchaser) is fully aware of his rights and obligations when seeking to claim under a warranty or receive a refund or replacement for products purchased (Products) from Aguzzo

5 Year Product Warranty - Domestic Use

This warranty applies to domestic residential installation. Under this Warranty for a period of 5 years from the date of purchase if the Product is found upon inspection by an Aguzzo authorised representative to be defective in construction, materials, composition, or assembly the Product will be repaired or exchanged with the same or an equivalent product at no charge to the Purchaser.

Warranty does not cover any labour or installation costs.

For installations other than for domestic residential purposes, the Warranty period is 12 months.

Warranty Conditions

The Warranty will apply only if the failure is due to a fault in the manufacture of the product, proof of purchase and the date of purchase is provided, and the claimant is the original purchaser of the Product, the installation and handling of the Product is done with due care and in accordance with the instructions provided, the claimed defect is reported by the Purchaser to Aguzzo within 10 business days of discovering the defect, and if hard-wired, evidence provided that it was installed by a qualified and licensed electrician.

This Warranty is void if the product is not used for the purpose for which it is designed.

Warranty Limitations

Standard warranty limitations apply. The Warranty does not cover faults; damage or loss caused by normal wear and tear, misuse, improper or abnormal use or application; failure to follow correct installation, normal operating, or proper care instructions of the Product; inadequate maintenance; chemical, abrasive, or electrical influences, installation in part or whole by a person who is not qualified and licensed installer or in a situation that is not fully compliant with Australian standards; repairs or tampering by unauthorised technicians, or any modifications to the Product; nor any damage, such as due to an accident, poor storage, dampness, liquid, fire, misuse, vandalism, or a corrosive environment.

Exclusions

To the maximum extent permitted by law, Aguzzo excludes all liability for damage or injury to any person, damage to any property, and any indirect, consequential or other loss or damage.

AQUZZO®

BEAUTIFUL BATHWARE